

DC Axial Fan 120x120x25mm

■ 尺寸图 (DIMENSION DRAWING)

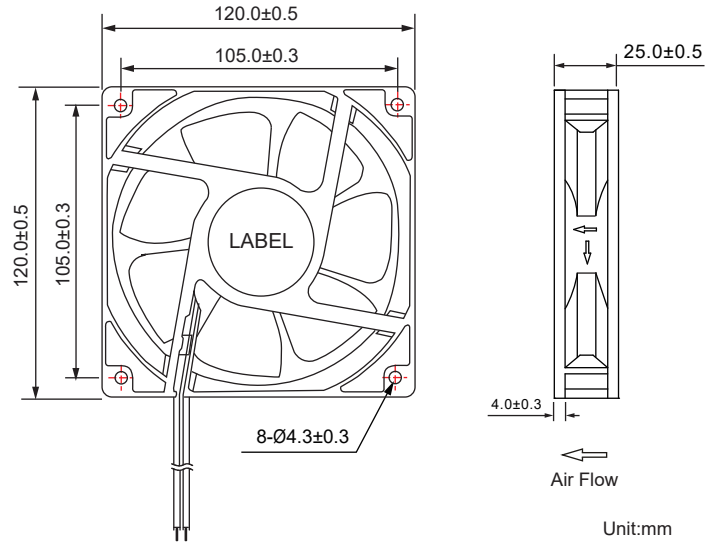

- * 轴承类型: 双滚珠轴承 (Bearing type: 2-Ball)
- * 材料(Material):
框叶(Frame & Impeller): PBT
- * 引线(Lead wire):
UL2468 AWG #26 or equivalent
红色线正级 Red Wire Positive (+)
黑色线负级 Black Wire Negative (-)
- * 可选择增加风扇功能(Functions are optional)
- * 重量(Weight): 178g

■ 风压&风量曲线图 P and Q CURVE

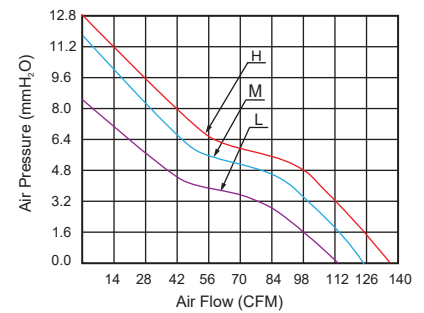

型号 Model	轴承类型 Bearing Type	版本 Version	电压 Rated Voltage	电流 Current	功率 Input Power	转速 Speed	风量 Air Flow	风压 Static Pressure	噪音 Noise Level
			VDC	Amp	Watt	RPM	CFM	MM-H ₂ O	dBA
CC12025L12D	2-Ball	-C	12V	0.46	5.52	4,000±10%	112.0	8.50	51.0
CC12025M12D	2-Ball	-C	12V	0.50	6.00	4,500±10%	121.0	11.7	54.0
CC12025H12D	2-Ball	-C	12V	0.60	7.20	5,000±10%	132.5	12.8	56.0
CC12025L24D	2-Ball	-C	24V	0.25	6.00	4,000±10%	112.0	8.50	51.0
CC12025M24D	2-Ball	-C	24V	0.50	12.0	4,500±10%	121.0	11.7	54.0
CC12025H24D	2-Ball	-C	24V	1.00	24.0	5,000±10%	132.5	12.8	56.0

- * 以上为额定电压下的常规参数(All readings are typical values at rated voltage)
- * 规格如有变动不另行通知(Specifications are subjected to change without prior notice)